

Warehouse & Loading Dock Solutions



Safety Products



Dockboards and Dock Plates

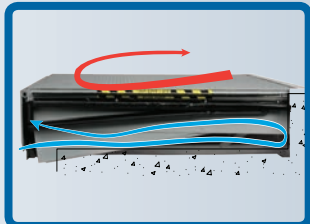

Energy Saving Products



Lighting Products



Protective Systems



Product Upgrades

APS RESOURCE
YOUR AFTERMARKET SOLUTION



APS Resource[®]
Your Aftermarket Solution

©2014 4Front Engineered Solutions, Inc. - APS Resource

SAFETY PRODUCTS



APS 2000® Vehicle Restraint

APS 2000® Vehicle Restraint

The APS 2000 is a superior rotating hook, impact-style vehicle restraint developed specifically to reduce the occurrence of accidents at the dock. The APS 2000 combines an advanced LED communication system with a low profile restraint carriage.

- Standard LED internal/external communication system improves safety
- Patented IP67S rated gear motor never needs adjustment
- Automatic Re-Engagement

Restraint Carriage Features:

- An impact extension bar with a service range of 9" to 25"
- A low profile 9" carriage
- Rotating steel hook engagement
- Zinc and dichromate plating for all-weather durability
- Zerk grease fittings on roller shafts; watertight electrical connectors

Advanced LED Communication System:

- Universal red and green light communication inside and outside the dock
- Position signaling
- Push-button operation with audible alarm override
- LED status lights in control box for easy troubleshooting

Patented Gear Motor:

- Electro-Mechanical brake motor never needs adjustment
- IP67S rated, protects against an immersion of water
- Hypoid/Helical gears are 93% efficient

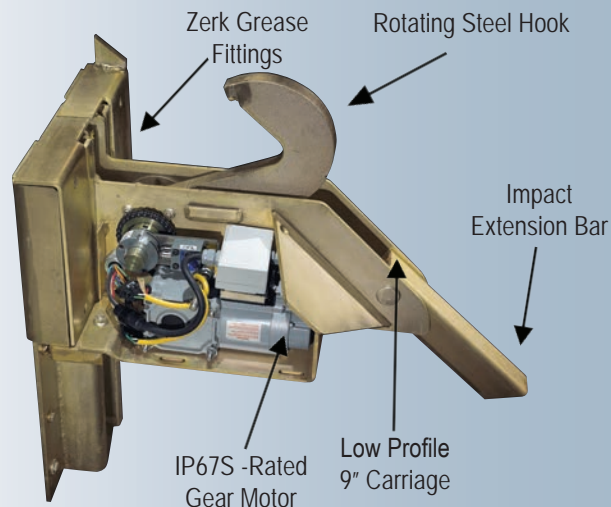
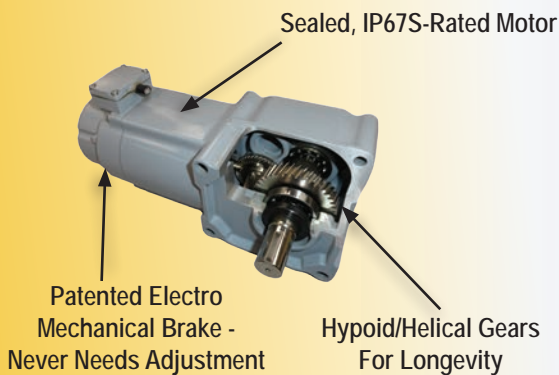

APS Resource®
Your Aftermarket Solution

©2014 4Front Engineered Solutions, Inc. - APS Resource

SAFETY PRODUCTS

Dock Impact Barrier™

The APS Resource Dock Impact Barrier is a manually operated gate barrier. When dock use is required, the Dock Impact Barrier is opened by releasing the foot latch and lifting the gate into an upright position with very little effort. Available in 6', 7', 8', 9' and 10' sizes.

- Reduces the occurrence of accidents due to forklifts, pallet jacks or pedestrians falling off the dock when the door is open
- Reduces the occurrence of damage to equipment, load, door panels and door track when the door is closed
- 9/16" - heavy-duty steel aircraft cable encased in flexible fiberglass rail withstands the impact of a 10,000 lb. fork truck moving at 4 mph.
- High visibility nylon netting and yellow 42" upper fiberglass rail provide additional personnel safety and meet the International Building Code
- Simple installation, minimal maintenance and easy operation
- 42" top rail meets OSHA 1910.23 standard for withstanding 200 lbs. of force from any direction

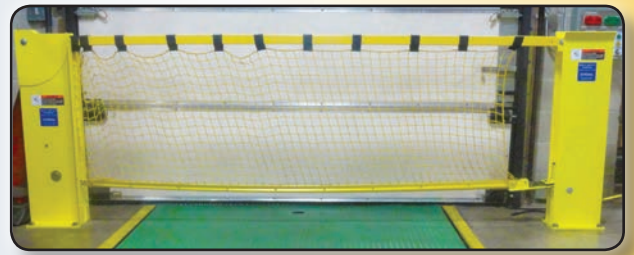

Dock Impact Barrier™

Dock Impact Barrier - LC™

The APS Resource Dock Impact Barrier - LC reduces damage to equipment, door panels and door track when door is closed while meeting limited overhead clearance requirements without impairing performance. Available in 8', 9' and 10' sizes.

- Maintains performance specification of withstanding 10,000 lb. impact at 4 mph.
- Low Clearance (LC) model requires 30" less of overhead clearance
- High visibility yellow/black striping
- 42" top rail meets OSHA 1910.23 standard for withstanding 200 lbs. of force from any direction



Dock Impact Barrier - LC™

Work Safe Gate™

The Work Safe Gate by APS Resource provides excellent visual protection for personnel. The yellow and yellow/black design provides high visibility. The easy to operate gate lifts effortlessly out of the opening for complete access. Available in 8', 9' and 10' sizes.

- Effective barrier for protecting personnel working in a hazardous area
- High visibility yellow/black striping
- Easy operation
- 42" top rail meets OSHA 1910.23 standard for withstanding 200 lbs. of force from any direction



Work Safe Gate™



APS Resource®

Your Aftermarket Solution

©2014 4Front Engineered Solutions, Inc. - APS Resource

DOCK LIGHTING



APS&GO - LED™



Dock Strobe™

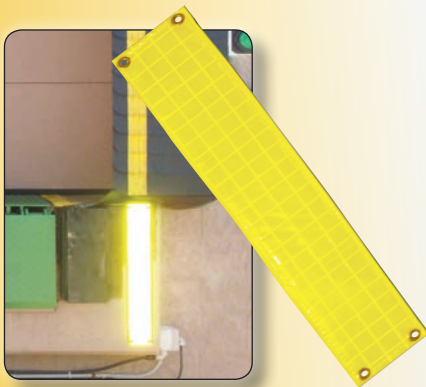

Reflect & Guide Stripe



Guide Lights and Control Box

APS&GO - LED™

The APS&GO - LED reduces the potential for serious accidents from truck drivers pulling away before loading/unloading is finished.

- High visibility red/green flashing LED lights with truck driver sign for simple, effective communication
- Compact, low-profile design reduces potential damage and fits between narrow seal/shelter designs
- Impact resistant polymer housing helps prevent corrosion
- Power cord for easy installation
- Long lasting LED technology for added safety
- UL and cUL approved
- 110VAC & 220VAC versions available

Dock Strobe™

The Dock Strobe will alert all employees to potentially dangerous situations using a 100-candela strobe tube light powered by two 6-volt, lantern batteries.

- Safety yellow casing and amber 360° dome for superior visibility
- Low profile, impact-resistant 4" dome
- Dual 3" heavy-duty industrial grade magnets on base
- High impact polypropylene; UV stabilized base for outdoor durability

Reflect & Guide Stripes

The easy to install Reflect & Guide Stripes enhance safety at the dock and throughout the facility.

- Weather resistant for long-term performance
- 47,000 microprisms per square inch provide intense reflective property
- Easy to install, no electrical hook-ups, no bulbs to replace and zero energy use
- 4" Wide; 10", 24" or 30" long

Guide Lights

Guide Lights provide an ideal focal point for drivers, greatly reducing the risk of "overrunning" the dock. The dual Guide Light's adjustable reflectors produce a focused light pattern that illuminates the dock surface exactly where needed to assist a driver in lining up the trailer square to the dock.

- Operates with on/off control console for both guide lights included
- Shallow depth reduces chance for impact by truck trailer
- High-impact polycarbonate construction with ribbed reinforcing
- High visibility from compact illumination on both sides of the door opening
- 115/12V AC/DC operation; dual light system is standard
- Standard (3) 12 Volt bulbs; also available in LED



APS Resource®
Your Aftermarket Solution

©2014 4Front Engineered Solutions, Inc. - APS Resource

DOCK LIGHTING

FT Ultra LED™ Dock Light

The 15 watt FT Ultra LED Dock Light from APS Resource provides an abundant amount of light output using less energy.

- 33" stainless steel flexible arm for easy positioning
- Significant energy saving 15 watt LED with 50,000 hour LED lamp life
- ON/OFF toggle switch and optional built-in 120V outlet
- Meets FDA and USDA requirements for food and pharmaceutical facilities
- Durable construction; designed to resist impact; ETL listed



FT Ultra LED™ Dock Light

High Impact LED™ Dock Light

The High Impact LED Dock Light delivers maximum light output using only 18 watts.

- Rugged, compact design for the most demanding applications
- Convenient recessed ON/OFF switch
- 18 watt LED with 60,000 hour LED lamp life
- 100-240VAC/60HZ
- Meets requirements for food and pharmaceutical facilities
- NEMA4; IP66 rated; UL & cUL listed



High Impact LED™ Dock Light

G-Flex LED Dock Light™

The G-Flex LED Dock Light uses a minimum amount of energy for the maximum light output into your trailer.

- 14 watt permanent LED
- Heavy Duty, flexible, 27" stainless steel arm that simplifies positioning
- 120V, 50/60 HZ
- Polycarbonate light head remains cool to the touch
- UL and cUL certified
- Great choice for food and pharmaceutical use
- **Also available:** G-Flex Dock Light™ with optional lamps



G-Flex LED Dock Light™

E-Saver™ LED Lamps

The APS Resource E-Saver LED Replacement Lamp saves significant amounts of energy with a rapid return on investment.

- Available in an 14 watt, PAR38 or 11 watt, PAR30 lamp
- LED uses less than 10% the energy of a traditional 150 watt incandescent bulb
- 50,000 hour extra long life expectancy
- Durable construction to withstand impact
- Meets requirements for food and pharmaceutical facilities
- North American Certifications: RoHS compliant, ETL certified, and FCC certified



E-Saver 30™ LED Lamp



E-Saver 38™ LED Lamp



APS Resource®

Your Aftermarket Solution

©2014 4Front Engineered Solutions, Inc. - APS Resource

WAREHOUSE FANS



Turbo-ES™ Fan

Turbo-ES™ Fan

Provides more airflow at lower amperage than any comparable truck fan on the market.

- Powerful 1/3 HP, 120V, 3.0 Amp, energy efficient motor
- Circulates up to 1275 CFM
- Durable steel construction withstands impacts
- Lightweight, compact size
- Dual articulating arm for precise positioning (sold separately)

Dock Light / Fan

Improves poor lighting and ventilation at the dock.

- 3-speed, 18", 5,500 CFM fan
- Available with 24", 42", 62" or 90" total arm reach
- Various light heads and optional energy saving lamps available
- UL listed



Dock Light/Fan
with High Impact LED™
Dock Light Head

Light Duty Industrial Ceiling Fans

Alternative when HVLS fans cannot be applied.

- 56" blade, 115V single phase, 3 curved steel blades
- Other models available

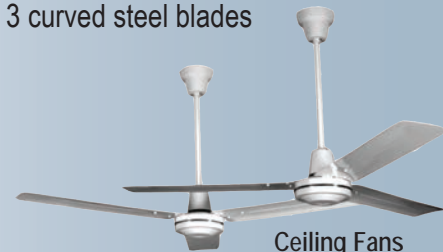

Ceiling Fans

Personnel Fans

Alternative when cage-style HVLS fans cannot be applied.

Portable Air Blower

- Belt Drive - 36" or 42" blades, 1 speed, 115V capacitor start motor
- Direct Drive - 30" or 36" blades, 2 speed, 1/3 HP motor

Air Circulator

- 30" blade, 1/3 HP, 2 speed motor, 115V single phase
- Pedestal or wall mount, available in chrome or safety yellow



Air Circulator



Portable Air Blower



APS Resource®

Your Aftermarket Solution

©2014 4Front Engineered Solutions, Inc. - APS Resource

PROTECTIVE SYSTEMS

Drain Pipe Protectors

Drain Pipe Protectors are a cost-effective way to help eliminate damage to unprotected drain pipes.

- Absorbs and dissipates direct impact
- High visibility safety yellow powder coating
- Available in wall-mount or I-Beam mount; 42" high

Rack Post Protectors

Rack post protectors are a cost-effective solution to protecting your racking systems from collapse during impact.

- Helps reduce potential injury from rack damage
- Constructed of rugged steel plates
- High visibility safety yellow powder coating
- Available in various heights (12", 18", 24") and lengths
- Single or double widths available

Fork Sentry

A heavy duty barrier to protect machinery and personnel from lift truck traffic. Rugged construction barrier provides safety to company assets.

- Heavy-duty, gusseted, 8" high construction
- High visibility safety yellow powder coating
- Provides safety to machinery, personnel and company assets
- Protects from lift truck traffic and forks
- 18", 36", 48", 60", 96", 108" length sizes available
- Other sizes available upon request

Bollards

Enhance your property's appearance without costly painting or clean-up!

Pipe Bollards

- Protection for loading docks, door jambs and other in-plant areas susceptible to a moving vehicle collision
- Available in heavy-duty 6" or 4" diameter pipe
- Powder coated safety yellow for high visibility
- Cap is standard

Bollard Covers

- Fit securely over existing bollard posts
- Constructed of 1/8" thick, high density, UV stabilized polyethylene for durability and long life
- OSHA yellow; enhances visibility with red or blue reflective stripes
- Easy installation
- Various sizes available



Drain Pipe Protector



Upright Protector



Rack Post Protectors



Fork Sentry



Bollard Covers



Pipe Bollard



APS Resource[®]

Your Aftermarket Solution

©2014 4Front Engineered Solutions, Inc. - APS Resource

PROTECTIVE SYSTEMS



The unique construction of the panel allows it to flex, providing durability and reliable operation

FLEX-BACK™ Door Panel

The FLEX-BACK Panel is the answer to common lower door panel damage, one of the most frequent and costly maintenance problems in today's busy warehouse.

- High impact polymer skin and flexible tube frame allows the panel to flex upon impact and return to its normal operating position
- Provides an exceptional thermal seal
- Installs easily using standard door hardware
- Heavy duty, easy grip handle comes standard
- Thick, 1¾" construction fits most common doors
- Available in most popular sectional door sizes: 8'2", 9'2" and 10'2" and custom sizes



FLEX-BACK™ Door Panel Flexes Upon Impact

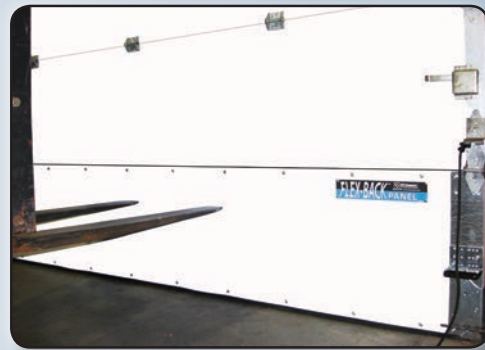

FLEX-BACK™ Door Panel Flexes Upon Impact

Cool Breeze Ventilation Panel™

The Cool Breeze Ventilation Panel gives you the flexibility of a window or a cool breeze opening.

- Stainless steel, FDA-approved window screen
- Clear, durable polycarbonate window pane
- Window frame pitched to drain to the building exterior
- Dual locks for security
- Easy to use aluminum handle for opening and closing
- Available in 8'2", 9'2" and 10'2" and custom sizes
- Available in single or dual vent options



Cool Breeze Dual Ventilation Panel



APS Resource®
Your Aftermarket Solution

©2014 4Front Engineered Solutions, Inc. - APS Resource

PROTECTIVE SYSTEMS

Bumpers

Provide maximum protection against vehicle damage to the building, dock leveler, restraint, seal or shelter. A wide variety to choose from in vertical and horizontal bumpers.

Molded Bumpers

- Perfect for low traffic dock use
- Unique design and construction achieves high impact resistance and long life
- Molded in one piece; compact size
- Weather resistant; maintenance-free



Molded Bumpers

Laminated Bumpers

- Absorb over 80% of truck impact and help protect dock and building
- Thick reinforced rubber pads laminated between heavy steel angles for stability and strength
- Help eliminate costly repairs from severe shock to docks



Laminated Bumpers

Steel Bumpers

- Rubber pads with reinforced steel-face absorb and deflect shock for maximum dock and building protection
- Recommended for heavy-duty and air-ride trailer applications
- Cost-effective due to long wear expectancy
- Impervious to weather damage; maintenance-free



Dock Defender Bumper

Steel-Faced Bumper

Security Gates

APS Resource provides a variety of security gates to fit all your needs.

Bi-parting Security Gate

- Variety of widths and heights available
- Extra-heavy steel construction
- Standard galvanized finish for durability
- Designed to secure dock doors without sacrificing visibility or air circulation

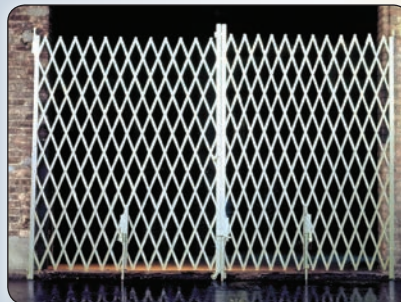

Bi-parting Security Gate

Single-slide Security Gate

- Variety of widths available (up to 11ft.)
- 6' - 8' height in use
- Extra-heavy steel construction
- Standard galvanized finish for durability



Single-slide Security Gate



APS Resource[®]

Your Aftermarket Solution

©2014 4Front Engineered Solutions, Inc. - APS Resource

PROTECTIVE SYSTEMS



Sentry-Rail



Sentry-Rail LT



Trak-Sentry



Z-Guard



Poly-Barrel Column Protector

Sentry-Rail™

High visibility and structural integrity provide needed protection throughout your facility.

- Available in double rail (42" h) and single rail (18" h)
- Optional swing gate, lift-out rail and offset posts available
- Rails are 11 gauge high tensile strength steel
- Posts are 4" square high tensile strength steel with a 5/8" thick baseplate
- Withstands a 10,000 lb. load at 4 mph

Sentry-Rail LT™

Effective visual barrier for protecting equipment and personnel working in a hazardous area.

- Steel, powder coated yellow 8' lift out rails can be custom cut in the field
- 42" double rail meets OSHA 1926.502 standard for fall protection systems

Trak-Sentry™

Trak-Sentry wraps securely around the door's track without interfering with normal door operation.

- Sold in pairs; right-hand and left-hand specific mounting
- Powder coated safety yellow for high visibility and lasting durability
- Available in 3/16" (Standard Duty) or 1/4" (Heavy Duty) thick steel
- Custom sizes available

Z-Guard

This compact system takes up less valuable floor space by eliminating the base plate.

- Available in 3/16" (Standard Duty) or 1/4" (Heavy Duty) thick steel
- Custom sizes available
- Powder coated safety yellow for high visibility and lasting durability

Column Protectors

Protects against structural damage to I-Beams from forklifts and other equipment by absorbing impact.

Poly-Barrel Column Protectors

- High-density polyethylene protectors have UV inhibitors and are rust and stress resistant
- Impact tested to handle a 7,000 lb. forklift at 6 mph
- Deflect impact and guard against damage caused by forklifts, hand trucks, drum dollies and personnel traffic
- Quick and easy installation; no tools required



APS Resource®

Your Aftermarket Solution

©2014 4Front Engineered Solutions, Inc. - APS Resource

ENERGY SAVING PRODUCTS

ENERGY GUARD® Retrofit Kits

ENERGY GUARD Retrofit Kits provide a superior perimeter seal along the sides and rear of the dock leveler and block dirt, debris, pests and energy loss.

- Available for most Kelley®, Serco® and some competitive dock levelers
- Eliminates gaps around sides and rear of dock leveler; seals lifting holes
- Prevents mass flow of air, minimizing transfer of heat into and out of facility
- Allows easy access to EZ Clean front frame and pit for maintenance
- Kits fit common dock leveler lengths and widths
- “Low profile” version available for narrow pit gaps

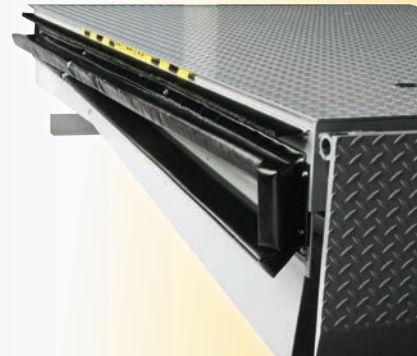

ENERGY GUARD® Retrofit Kit

Dock Leveler Weatherseal

Dock Leveler Side Brush Seal

- Fits snugly in the gaps between pit walls and dock levelers for maximum protection against the elements
- PVC dock leveler seal also available



Chain Sealr™

- Helps prevent pests from entering the facility through the chain opening of the dock leveler
- Available in two sizes - 1.75" or 2.5" diameter

Rear Spiral Brush Seal

- This innovative, new, brush-style rear hinge seal fits securely in the rear hinge gap of the dock leveler

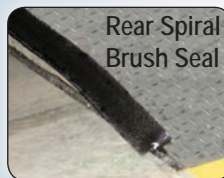

Dock Leveler Brush Seal

Door Weatherseal

Door Brush Seal

- Dense polypropylene bristle weatherseal
- Available in numerous door panel widths; 1.5", 2" and 3" bristle lengths
- Standard 45° or 180° aluminum extrusion for effective door sealing



Door Brush Seal

Edge Sealr™

- Provides an extra tight seal between the dock leveler and overhead door
- Constructed of 22 oz. vinyl; available up to 12' with or without side flaps
- Custom lengths and widths available



Edge Sealr™

Door Sprag™

- Fills the gap between the dock leveler and pit wall



Door Sprag™

Dock Stufr®

The Dock Stufr easily and inexpensively eliminates dock gaps.

- Constructed from heavy-duty coated fabric for durability and long life
- Includes strap for portability and attachment grommet
- Available in 18" and 30" lengths



Dock Stufr®



APS Resource®

Your Aftermarket Solution

©2014 4Front Engineered Solutions, Inc. - APS Resource

SAFETY PRODUCTS

Visual Barriers

Belted Visual Barrier

- 14 ft. yellow/black 3" strip for high visibility
- Trak Sentry with visual barrier provide 48" high door track protection (optional)

Steel Visual Barrier

- 48" tall x 12' wide; high visibility yellow/black steel barrier
- Lightweight design; additional double-wide (22') wheeled cart design available
- Highly visible strobe light for added safety (optional)

Canvas Visual Barrier

- 4' tall x 10' wide; high visibility large warning signs
- Light fabric and plastic design easily move and fold into a compact space



Belted Visual Barrier



Canvas Visual Barrier

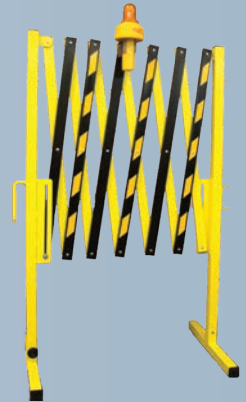

Steel Visual Barrier

Wheel Chocks & Chains

OSHA recommends trailer wheels be chocked during loading and unloading to prevent trucks from rolling. 3/16" plated coil chain sold separately. Optional "Truck Wheels Must Be Chocked" sign available.

Laminated Wheel Chocks

- Extra heavy-duty laminated rubber pads compressed between steel plates
- Contoured to fit tire; reversible

Aluminum Wheel Chocks

- Light weight, non-sparking extruded aluminum
- Surface gripping teeth on underside

Molded Wheel Chocks

- Available in molded rubber or urethane
- Designed to fit both the tire or the pavement
- Available in black or orange



Laminated, Aluminum and Molded Wheel Chocks



APS Resource®
Your Aftermarket Solution

©2014 4Front Engineered Solutions, Inc. - APS Resource

SAFETY PRODUCTS

Trailer Stabilizers

OSHA recommends trailer stabilizers to help reduce accidents from trailer-tip and landing gear collapse during loading and unloading, when a tractor does not support the trailer.

Heavy Duty Hold Safe Stabilizer

- Static capacity: 100,000 lbs.; lifting capacity: 50,000 lbs.
- Two-speed gear box
- Service range: 41-3/4" to 55-1/4"
- Large 16" solid urethane tires



Heavy Duty Hold Safe Stabilizer

Heavy Duty Ratchet Beam

- Static capacity: 100,000 lbs.; lifting capacity: 50,000 lbs.
- Service range: 39-1/2" to 51"
- Two-way reversible hand ratchet
- Heavy Duty 8" semi-pneumatic tires



Heavy Duty Ratchet Beam

Medium Ratchet Beam

- Static capacity: 100,000 lbs.; lifting capacity: 40,000 lbs.
- Service range: 39-1/2" to 51"
- Threaded screw design
- Heavy Duty 8" semi-pneumatic tires



Medium Duty Ratchet Beam

Wheel Guides

Heavy-duty wheel guides direct the truck into the correct position at your dock.

Wheel Guide

- High visibility safety yellow to stand out in the driveway
- Heavy-duty pipe style guides with dual mounting plates
- Standard size is 8' or 12' in length



Wheel Guide

Wheel Guide with Flare

- High visibility safety yellow to stand out in the driveway
- Heavy-duty 5-1/2" diameter pipe
- Available in 8', 9' or 10' sizes with 32" flare



Wheel Guide with Flare



APS Resource[®]

Your Aftermarket Solution

©2014 4Front Engineered Solutions, Inc. - APS Resource

DOCKBOARDS AND DOCK PLATES

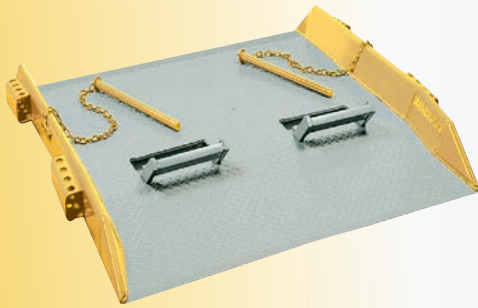

Heavy Duty Steel Dockboard



Steel Dockboard with Lifting Chain

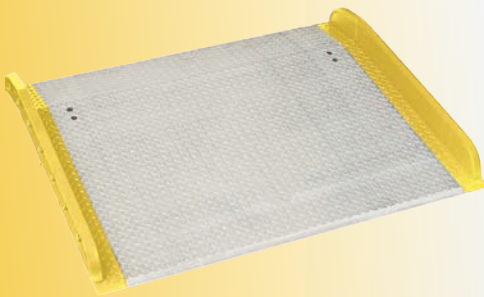

Aluminum Dockboard with Steel Curbs

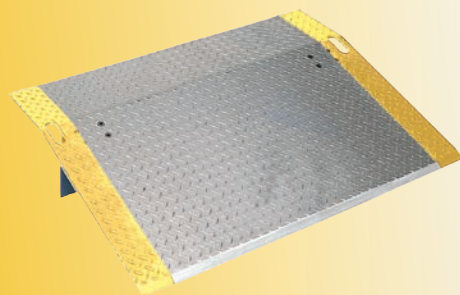

Aluminum Dock Plate

Dockboards

Convenient dockboards manufactured by APS Resource are the answer for low volume, dock use when cost and portability are a concern.

Heavy Duty Steel Dockboards

- Two 4-hole pin pockets placed on each end
- Integral, all-welded, steel anti-runoff curbs
- Tough, fold-down forklift loops for safe, fast positioning
- Available in 15,000 or 20,000 lb. capacities
- Available in 60" to 84" widths

Steel Dockboards with Lifting Chain

- Bolt-on steel curbs help prevent loading equipment runoff
- Locking legs for safe loading
- Available in capacities up to 10,000 lbs.; forklift chains included

Aluminum Dockboards with Steel Curbs

- Available in 10,000-15,000 lb. capacities
- Bolt-on steel curbs prevent loading equipment runoff
- Locking legs for safe loading
- 11° lip bend and beveled deck edges for smooth transition
- 11" standard lip length for conventional trailers
- 14" lip length available for refrigerated applications
- Available in 60" to 72" widths and 36" to 72" lengths

Dock Plates

For light duty and low volume applications.

Aluminum Dock Plates

- Ideal solution for pallet trucks and other non-powered loading equipment
- Bolt-on steel legs for safety
- 11° lip bend and beveled deck edges for smooth transition
- 11" standard lip length for conventional trailers
- 14" lip length available for refrigerated applications

Rail Dock Plates

- Custom built for your application
- Available in numerous sizes and capacities



APS Resource®

Your Aftermarket Solution

©2014 4Front Engineered Solutions, Inc. - APS Resource

PRODUCT UPGRADES

LED Light Upgrades for Vehicle Restraints

LED upgrades available for both inside and outside red/green lights. Replace higher maintenance incandescent bulbs with safer, long lasting LED technology.

- 90% less energy consumed than a traditional incandescent bulb
- No maintenance, extra long lamp life, high vibration resistance
- Available in 12-24V & 115V low-profile design



Inside LED Upgrade



Outside LED Upgrade

ATC - Air Conversion Kit™

The patented ATC (Air Technology Conversion) Kit will extend the life of your old dock leveler and make it more efficient while lowering your operating costs. The ATC Kit converts levelers of most major manufacturers and can be installed easily. The airbag lifting module is made of tough, PVC-coated polyester fibers that operates without loss of performance in temperatures from -65 to +200 °F, even if the bag is punctured.

- Easy push-button operation
- Ergonomic design increases safety and productivity
- Proven technology - tested fully effective at over 200,000 cycles
- Environmentally friendly
- Lowest lifetime ownership cost
- 110V Single Phase



Low Pressure Fan Motor



ATC - Air Conversion Kit

HTC - Hydraulic Conversion Kit™

Fully hydraulic activation in a conversion kit combines ease of operation with low operating costs. Hydraulic main cylinder with hydraulic lip activation makes this kit a complete upgrade for your leveler. Velocity fuse included for emergency safety.

- ¾ HP motor/pump assembly; 1 HP for the three phase
- Hydraulic main cylinder and lip cylinder comes with all necessary hoses, fittings and brackets
- Easy to use, constant pressure push-button control
- Velocity fuse emergency safety system
- Single phase or three phase power



Motor & Cylinders



HTC - Hydraulic Conversion Kit



APS Resource®

Your Aftermarket Solution

©2014 4Front Engineered Solutions, Inc. - APS Resource

APS RESOURCE'S COMPREHENSIVE LINEUP INCLUDES:

| | |
|---|--|
| airDefense® Retro Fit Kits | HTC - Hydraulic Conversion Kit™ |
| APS&GO - LED™ Safety Light Systems | Kelley Atlantic Brand Service Parts |
| APS 2000® Rotating Hook Vehicle Restraint | Kelley® Brand Service Parts |
| ATC - Air Conversion Kit™ | Laminated Dock Bumpers |
| Bollard Covers | LED Guide Lights |
| Bumper Brackets & Buildouts | LED Upgrade Kits |
| Column Protectors | Metal Head Dock Lights |
| Cool Breeze Ventilation Panel™ | Molded Dock Bumpers |
| Curb Angle Sets | Pipe Bollards |
| Dock Bumpers | Pit Kits |
| Dock Defender™ Bumper | Polycarbonate Head Dock Lights |
| Dock Guide Lights | Portable Dock Plates & Dockboards |
| Dock Impact Barrier™ | Portable Rail Ramps |
| Dock Impact Barrier - LC™ | Rack Post Protectors |
| Dock Light / Fan Combinations | Rear Spiral Seal |
| Dock Seal Recovers | Reflect & Guide Stripes |
| Dock Seal Wear Pleats | Rite-Hite® Brand Service Parts |
| Dock Strobe™ | Security Dock Gates |
| Dock Stufr® | Sentry-Rail™ Guard Railing |
| Dock Visual Barrier | Sentry-Rail - LT™ Guard Railing |
| DOK-LOK® Replacement Parts | Serco® Brand Service Parts |
| Door Edge Sealr™ | Spring Head Dock Lights |
| Door Section Saver | Stand-off Kits for Restraints |
| Door Sprag™ Seals | Steel Faced Dock Bumpers |
| Drain Pipe Protectors | Steel Pit Kits |
| ENERGY GUARD® Retrofit Kits | Trak-Sentry™ Door Track Protectors |
| E-Saver 30™ LED Lamp | Truck Alert Light Communication Systems |
| E-Saver 38™ LED Lamp | Turbo-ES™ Fan |
| Extra Length Dock Bumpers | T-Track Weatherseal, Brush & PVC |
| FLEX-BACK™ Door Panel | Visual Barriers |
| Fork Sentry | Weatherseal Kits for Dock Levelers & Doors |
| FT Ultra LED™ Dock Light | Wheel Chocks & Chains |
| G-Flex Dock Light™ | Wheel Risers |
| G-Flex LED Dock Light™ | Work Safe Gate™ |
| High Impact LED™ Dock Light | Yard Ramps |
| High Pressure Sodium Dock Lights | Z-Guard Door Track Protectors |
| Hold-Safe™ Trailer Stabilizer | |

Your APS Resource Local Distributor Is:

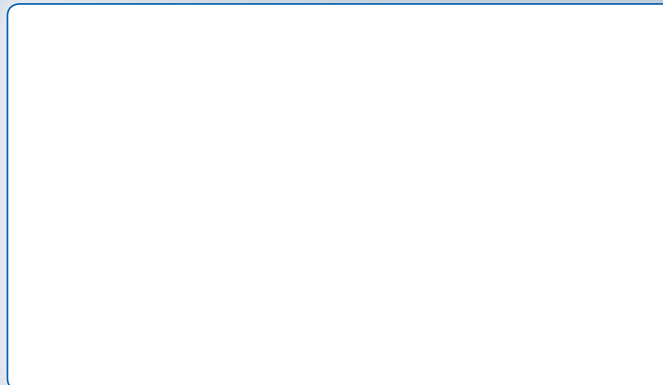

As part of our policy of continuous product improvement, we reserve the right to change specifications at any time.

